

Round Ceiling Radiation Fire Damper Model 420-R

Features – U.L. rated 3 hour ceiling fire damper. Meets NFPA 90A & UL 555C (Not rated for UL wood truss ceiling design)

STANDARD CONSTRUCTION

COLLAR

2-1/2" (60) deep, 22 gauge (1.0) galvanized steel

BLADES

22 gauge (1.0) galvanized steel with a Ceramic Fiberglass outer cover for dampers over 10" (254) diameter.

MAXIMUM U.L. CLASSIFIED SIZE

24" Diameter

MINIMUM U.L. CLASSIFIED SIZE

4" Diameter (102)

UNDERSIZED

1/8" under ordered size unless specified Exact or Actual

FUSIBLE LINK

165°F Standard (74°C)

FINISH

Galvanized

OPERATOR

None

OPTIONAL CONSTRUCTION

OPERATOR – Hand adjustable volume controller.

FUSIBLE LINK – 212°

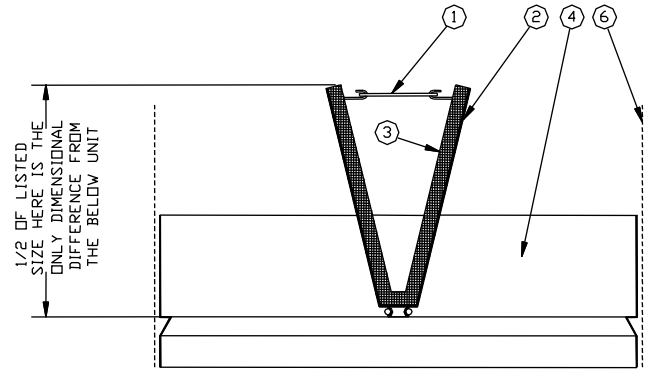
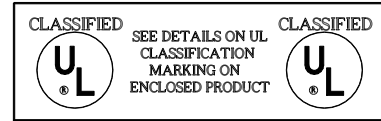

This unit is dimensionally equal to the unit below – less the controller

- KEY TO DRAWINGS** – 1. Fusible Link
2. Blades
3. Ceramic and Fiberglass
4. Frame
5. Volume Controller
6. Duct drop (by others)

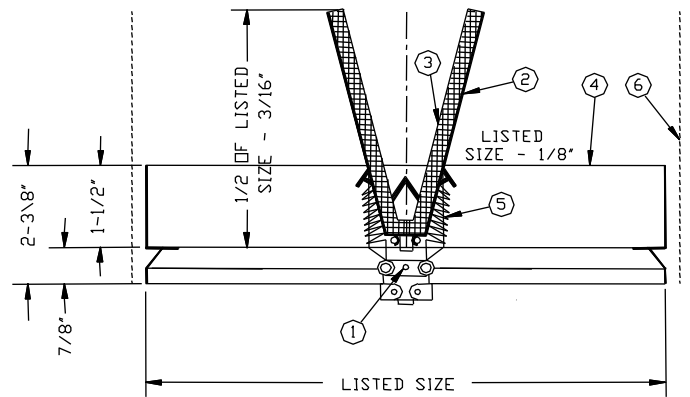
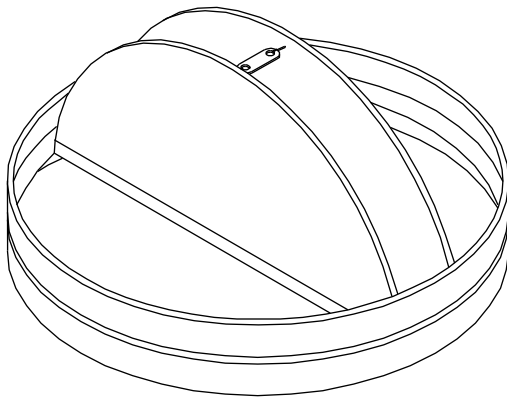

DATE	ARCHITECT			ENGINEER
PROJECT				
ITEM	QTY	W	H	DESCRIPTION